



Saugrohre
Suction Tubes
Tubes d'aspiration
Tubos de aspiración
Tubi d'aspirazione

Saugrohre
Suction Tubes
Tubes d'aspiration
Tubos de aspiración
Tubi d'aspirazione

Nutzlänge
working length
longueur utile
largo útil
lunghezza utile

	ø 1,5 mm 4 - 5 Charr.	ø 2,0 mm 6 Charr.	ø 2,5 mm 7 - 8 Charr.	ø 3,5 mm 13 - 14 Charr.	ø 4,5 mm 16 - 17 Charr.
13 cm/5"	40.286.13	40.287.13	40.288.13	40.289.13	
15 cm/6"	40.286.15	40.287.15	40.288.15	40.289.15	
18 cm/7"	40.286.18	40.287.18	40.288.18	40.289.18	40.289.45
22 cm/8¾"	40.286.22	40.287.22	40.288.22	40.289.22	

Schlaucholive ø 6,5 - 9 mm
Olive ø 6,5 - 9 mm
Oliva ø 6,5 - 9 mm
Oliva ø 6,5 - 9 mm

LUER

½

YASARGIL



mit zentraler Bohrung
with central bore
avec trou central
con un foro centrale
con un agujero central

04.149.27

ø 2,0 mm

04.148.27

ø 4,8 mm

½
YANKAUER
28,5 cm/11¼"



04.155.30

ø 3,0 mm

Fig. 1

04.155.35

ø 3,5 mm

Fig. 2

04.155.40

ø 4,0 mm

Fig. 3

04.155.99

Mandrin
Stylet
Doigt
Esfilete
Stiletto

½
MAGILL
24,5 cm/9¾"

Saugkanülen mit Unterbrecher und Mandrin
Suction Cannulae with finger cut-off and stylet
Canules d'aspiration avec interrupteur à doigt
Cánulas para aspiración con interruptor y estilete
Cannule per aspirazione con interruttore e stiletto



½
ADSON
40.290.16
16,5 cm/6½"
ø 3 mm



½
ADSON
40.290.21
21 cm/8¼"
ø 4 mm



½
FRAZIER
40.290.24
24 cm/9½"
ø 3,3 mm

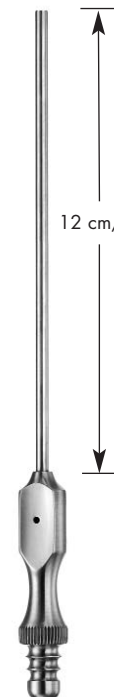

½
FRAZIER
40.292.08
ø 2,7 mm/ 8 charr.

12 cm/4¾"

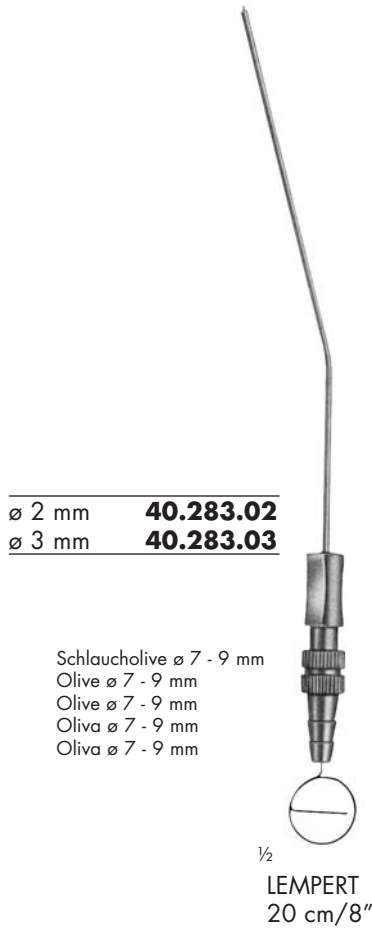

ø 2 mm **40.283.02**
 ø 3 mm **40.283.03**

Ø mm	F.G. Charr.	11 cm/4 1/4"	13 cm/5"	16 cm/6 1/4"	20 cm/8"
ø 1,5 mm	4 - 5	40.270.15	40.271.15	40.272.15	40.273.15
ø 2,0 mm	6	40.270.20	40.271.20	40.272.20	40.273.20
ø 2,5 mm	7 - 8	40.270.25	40.271.25	40.272.25	40.273.25
ø 3,0 mm	9	40.270.30	40.271.30	40.272.30	40.273.30
ø 4,0 mm	12	40.270.40	40.271.40	40.272.40	40.273.40
ø 5,0 mm	15	40.270.50	40.271.50	40.272.50	40.273.50

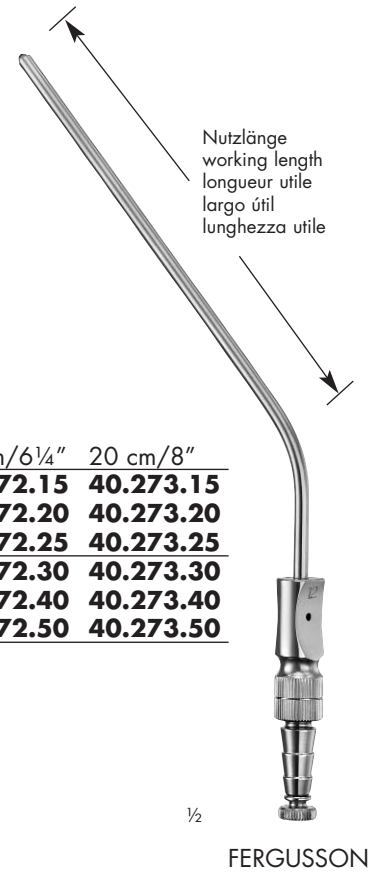

Schlaucholive ø 6 - 9 mm
 Olive ø 6 - 9 mm
 Olive ø 6 - 9 mm
 Oliva ø 6 - 9 mm
 Oliva ø 6 - 9 mm

Saugkanülen mit Unterbrecher und Mandrin
 Suction Cannulae with finger cut-off and stylet
 Canules d'aspiration avec interrupteur à doigt
 Cánulas para aspiración con interruptor y estilete
 Cannule per aspirazione con interruttore e stiletto

F.G. Charr.	Ø mm	30°	75°
6	2,0	40.295.06	40.297.06
7	2,3	40.295.07	40.297.07
8	2,7	40.295.08	40.297.08
9	3,0	40.295.09	40.297.09
10	3,3	40.295.10	40.297.10
11	3,7	40.295.11	40.297.11
12	4,0	40.295.12	40.297.12
15	5,0	40.295.15	40.297.15



Saugrohre
Suction Tubes
Tubes d'aspiration
Tubos de aspiración
Tubi d'aspirazione

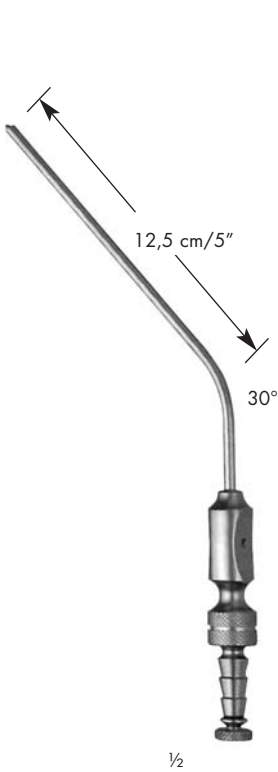

1/2

FRAZIER

6 Charr.	40.293.06
8 Charr.	40.293.08
9 Charr.	40.293.09
10 Charr.	40.293.10
12 Charr.	40.293.12

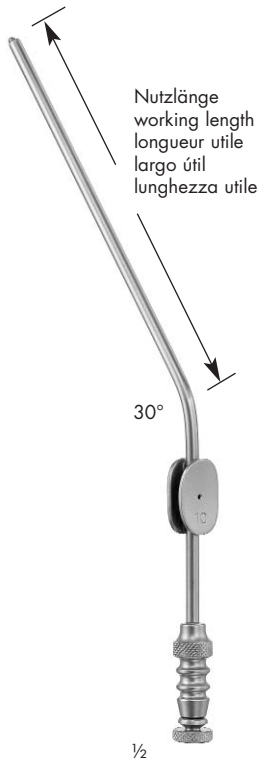

1/2

FRAZIER

F.G. Charr.	ø mm	12,5 cm/5"	18 cm/7"
6	2,0	40.296.06	40.296.16
8	2,7	40.296.08	40.296.18
10	3,3	40.296.10	40.296.30
12	4,0	40.296.12	40.296.32

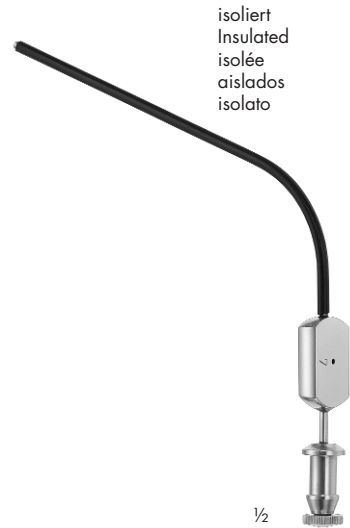

1/2

FRAZIER

	19 cm/7 1/2"
7 charr.	40.299.07
9 charr.	40.299.09
11 charr.	40.299.11

Spitze 6,5 mm breit
tip 6.5 mm wide
6,5 mm de large
6,5 mm de ancho
6,5 mm di larghezza

40.294.05
18 cm/7"
ø 5 mm

Schlaucholive ø 6 - 9 mm
Olive ø 6 - 9 mm
Olive ø 6 - 9 mm
Oliva ø 6 - 9 mm
Oliva ø 6 - 9 mm

1/2

ø 4,5 mm **40.307.45**
ø 5,5 mm **40.307.55**



1/2

LUER
17,5 cm/7"

Schlaucholive ø 6 - 9 mm
Olive ø 6 - 9 mm
Olive ø 6 - 9 mm
Oliva ø 6 - 9 mm
Oliva ø 6 - 9 mm

4-5 charr. ø 1,5 mm **40.313.15**
6 charr. ø 2,0 mm **40.313.20**
7-8 charr. ø 2,5 mm **40.313.25**
9 charr. ø 3,0 mm **40.313.30**

Schlaucholive ø 6 - 9 mm
Olive ø 6 - 9 mm
Olive ø 6 - 9 mm
Oliva ø 6 - 9 mm
Oliva ø 6 - 9 mm

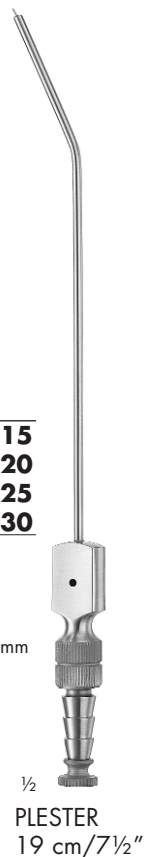

1/2

PLESTER
19 cm/7 1/2"

Hirnventrikelpunktionskanülen

Ventricle of cerebrum puncture cannulas
 Canules pour la ponction des ventricules cérébraux
 Cánulas para la punción del ventriculo cerebral
 Cannule per la puntura del ventricolo cerebrale

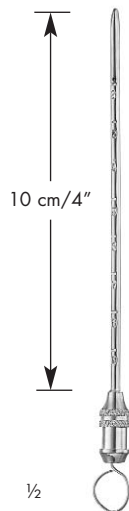

FRAZIER
 12 cm/4³/₄"

ø 2,0 mm	40.298.08
ø 2,5 mm	40.298.10
ø 3,0 mm	40.298.12

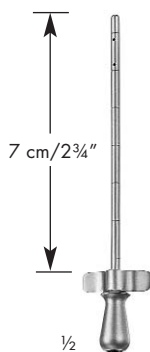

ø 2,0 mm	40.300.20
ø 2,5 mm	40.300.25



CONE
 9 cm/3¹/₂"

12 G. Ø 2,64 mm	40.302.12
13 G. Ø 2,24 mm	40.302.13
14 G. Ø 2,03 mm	40.302.14
15 G. Ø 1,83 mm	40.302.15
16 G. Ø 1,62 mm	40.302.16
17 G. Ø 1,42 mm	40.302.17
18 G. Ø 1,22 mm	40.302.18
20 G. Ø 0,91 mm	40.302.20

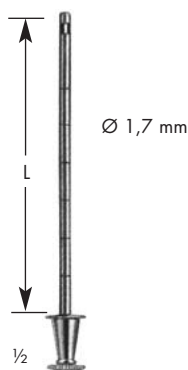

JEFFERSON

8 cm/3 ¹ / ₄ "	40.301.08
10 cm/4"	40.301.10

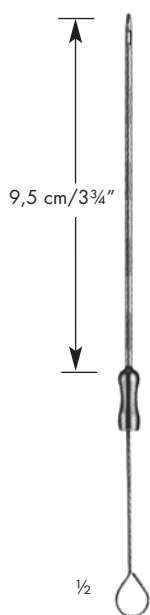

DANDY

ø 2,0 mm	40.303.20
----------	------------------

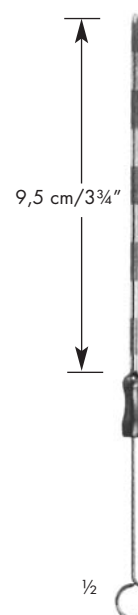

CUSHING-CAIRNS

ø 2,3 mm	40.304.23
ø 2,6 mm	40.304.26

Saugrohre
Suction Tubes
Tubes d'aspiration
Tubos de aspiración
Tubi d'aspirazione



1/2

ZOELLNER
40.283.70
18 cm/7"



ZOELLNER
5,5 cm/2"

ø 1,2 mm / 18 swg	40.283.71
ø 1,0 mm / 20 swg	40.283.72
ø 0,7 mm / 22 swg	40.283.73
ø 0,5 mm / 24 swg	40.283.74
ø 0,4 mm / 26 swg	40.283.75

Schlaucholive ø 8 mm
Olive ø 8 mm
Olive ø 8 mm
Oliva ø 8 mm
Oliva ø 8 mm



1/2

WULLSTEIN

40.308.00

Komplett, mit Griff und drei Ausfätzen
complete, with handle and 3 tips
complet, avec manche et 3 pointes
completo, con mango y 3 puntas
completo, con manico e 3 punte

40.308.01

14 cm/5 1/2"

Saugerhandgriff
Suction Handle
Manche pour canule
Mango para cánula
Manico d'aspirazione

Mikro-Saugkanüle
Micro suction cannula
Tube micro d'aspiration
Micro tubo de aspiración
Micro-cannula d'aspirazione



40.308.04
4,5 cm/1 3/4"
ø 0,4 mm

40.308.06
4,5 cm/1 3/4"
ø 0,6 mm

40.308.08
4,5 cm/1 3/4"
ø 0,8 mm

40.309.00

Komplett, mit Griff und 4 Ausfätzen (x 2)
complete, with handle and 4 tips (x 2)
complet, avec manche et 4 pointes (x 2)
completo, con mango y 4 puntas (x 2)
completo, con manico e 4 punte (x 2)



40.309.01

Saughandgriff
Suction Handle
Manche pour canule
Mango para cánula
Manico d'aspirazione



ø 0,5 mm	40.309.02
ø 0,7 mm	40.309.03
ø 1,0 mm	40.309.04
ø 1,3 mm	40.309.05



BELLUCCI
40.310.00

Komplett, mit Griff und drei Ausfätzen
complete, with handle and 3 tips
complet, avec manche et 3 pointes
completo, con mango y 3 puntas
completo, con manico e 3 punte



Schlaucholive ø 8 mm
Olive ø 8 mm
Olive ø 8 mm
Oliva ø 8 mm
Oliva ø 8 mm

ø 1,0 mm / 20 swg	40.310.02
ø 0,7 mm / 22 swg	40.310.03
ø 0,5 mm / 24 swg	40.310.04

BELLUCCI
40.310.01
15,5 cm/6"

mit Saugunterbrecher und Mandrin
with finger cut-off and stylet
avec interrupteur à doigt
con interruptor y estilete
con interruttore e stiletto

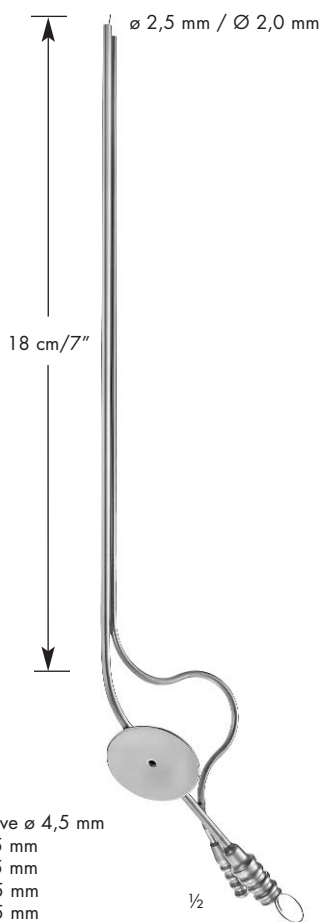

FISCH
40.331.17

Saug- und Spülkanüle
Suction and Irrigation Cannula
Instruments à aspiration et à irrigation
Instrumentos de aspiración y de lavado
Strumenti per aspirazione e lavaggio



YASARGIL
40.332.20
20 cm/8"
Ø 2,0/4,5 mm

Präpariersauger
Suction raspatory
Aspirateur pour préparation
Aspirador para preparación
Aspiratore per preparazione



LANDOLT
40.333.20
20 cm/8"
Ø 3,2 mm

Saugrohre
Suction Tubes
Tubes d'aspiration
Tubos de aspiración
Tubi d'aspirazione

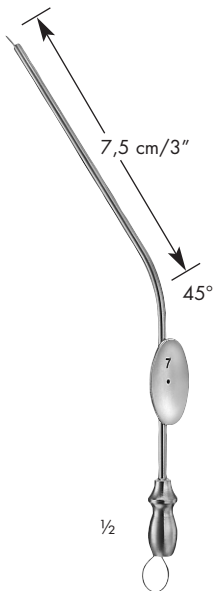

mit Unterbrecher
with finger cut-off
avec plaque interrupteur
con placa desconectadora
con placa interruttore

⊙
44.101.03
ø 1,0 mm

⊙
44.101.05
ø 1,5 mm

⊙
44.101.07
ø 2,0 mm

1/2

BARON



Schlaucholive ø 8 mm
Olive ø 8 mm
Olive ø 8 mm
Oliva ø 8 mm
Oliva ø 8 mm

1/2

SCHUHKNECHT
13 cm/5"

Saugadapter mit Saugunterbrecher
Suction adapter with finger cut-off
Adaptateur d'aspiration avec interrupteur
Adaptador para aspiración con interruptor
Adattator per aspirazione con interruttore



Schlaucholive ø 7 mm
Olive ø 7 mm
Olive ø 7 mm
Oliva ø 7 mm
Oliva ø 7 mm

HOUSE
44.104.00
5,5 cm/2 1/4"

ø 0,9 mm / 20 swg **44.102.20**
ø 0,6 mm / 24 swg **44.102.24**

Saugrohr
suction tube
à aspiration
de aspiración
per aspirazione

Spülrohr
irrigation tube
à irrigation
de lavado
per lavaggio

ø 1,8 mm	ø 1,8 mm	44.103.01
ø 2,0 mm	ø 2,0 mm	44.103.02
ø 3,0 mm	ø 2,0 mm	44.103.03
ø 4,5 mm	ø 2,0 mm	44.103.04
ø 0,9 mm	ø 0,7 mm	44.103.11
ø 1,2 mm	ø 0,9 mm	44.103.12
ø 1,5 mm	ø 1,2 mm	44.103.13

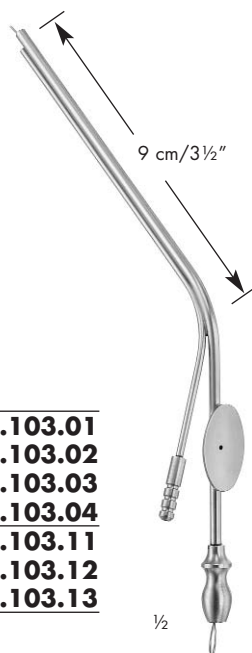

1/2

HOUSE

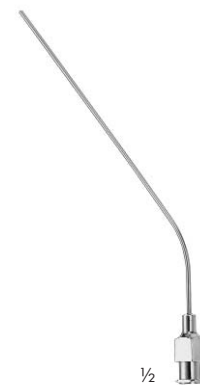

1/2

VERHOEVEN
10 cm/4"

ø 1,6 mm / 16 swg	44.105.16
ø 1,2 mm / 18 swg	44.105.18
ø 0,9 mm / 20 swg	44.105.20
ø 0,7 mm / 22 swg	44.105.22
ø 0,6 mm / 24 swg	44.105.24